



# AquiStar<sup>®</sup> GDL

Multi-Channel Datalogger



*True data, measure by measure*



---

# Table of Contents

Introduction .....	3
What is a GDL? .....	3
Initial Inspection and Handling .....	3
Do's and Don'ts .....	3
Getting Started .....	4
GDL Connectors .....	4
Connecting GDL to Computer .....	4
Aqua4Plus Software .....	4
Warm Up Time.....	5
Advanced Settings .....	5
Basic Configurations.....	5
Turning Channels On or Off.....	5
Setting Ranges on Milli-volt and Voltage Channels .....	6
Setting the Baud Rate .....	7
User Defined Units .....	9
Using Switched Output Voltage.....	11
Maintenance .....	12
Changing Batteries.....	12
Calibration .....	12
Reading the GDL via Direct Read .....	15
Setting Units for Direct Read .....	15
Reading Via Modbus® RTU .....	16
Reading Via SDI-12.....	18
Appendix A: Specifications.....	20
Channel Specifications.....	20
Power Supply.....	21
Enclosure .....	21
Appendix B: Wiring Diagrams .....	22
Communication Connector .....	22
Standard Sensor Connector.....	22
Dissolved Oxygen Connector .....	22
4-20 mA Connector.....	23
Strain Gauge Wiring .....	23
Internal Wiring and Connections .....	24
Appendix C: Alternate Connection Options .....	25
Connecting via RS232 Serial Port .....	25
Connecting with a USB/Serial Adapter .....	25
Reorder and Contact Information .....	26
Limited Warranty/Disclaimer - Aquistar® GDL Datalogger .....	27

Information in this document is subject to change without notice and does not represent a commitment on the part of the manufacturer. No part of this manual may be reproduced or transmitted in any form or by any means, electronic or mechanical, including photocopying and recording, for any purpose without the express written permission of the manufacturer.

---

## Introduction

### What is a GDL?

INW's *AquiStar*® GDL is a datalogger to which analog sensors can be attached and then read from INW's *Aqua4Plus* control software. It takes the analog signals and converts them into digital signals. The GDL board can read the sensors in real time or record sessions of data for later upload. This industry standard digital RS485 interface device records thousands of records, operates on low power, and features easy-to-use software with powerful features.

The GDL has two temperature, one milli-volt, two voltage, two 4-20 mA channels, and up to eight digital channels, depending on configuration.

An internal AA alkaline battery pack supplies 12 VDC to the GDL and optionally to connected sensors. The GDL is programmed using a laptop or desktop Windows® based computer and easy to use *Aqua4Plus* software. Once programmed the unit will measure and collect data on a variety of time intervals.

In addition to INW's *Aqua4Plus*, use standard Modbus® RTU or SDI-12 equipment to easily read the GDL, so as to tie into your existing networks.

**Version Information:** This manual refers to GDLs with 2.6 or higher firmware and *Aqua4Plus* version 1.8.6 or higher. If you have earlier versions and cannot access some features, contact INW for upgrade information.

---

### Initial Inspection and Handling

Upon receipt of your datalogger, inspect the shipping package for damage. If any damage is apparent, note the signs of damage on the appropriate shipping form. After opening the carton, look for concealed damage. If concealed damage is found, immediately file a claim with the carrier.

---

### Do's and Don'ts

*Do* handle the device with care.

*Don't* install the device such that the box or any of its connectors are submerged.

*Don't* support the device with the connector or with the connectors of an attached cable.

*Don't* bang or drop the device on hard objects.

---

## Getting Started

---

### GDL Connectors

This GDL comes with one communication connector for connecting to the computer, and several sensor connectors as needed. (See Appendix B for further wiring information)

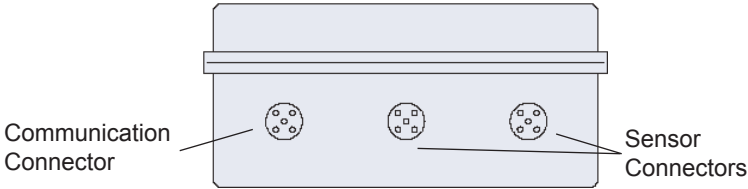

*The GDL has one communication connector and a variable number of sensor connectors, depending on your configuration.*

---

### Connecting GDL to Computer

Connect the GDL to your computer's USB port, as shown below. Drivers and instructions come with the adapter. (For alternate connection options, see Appendix C.)

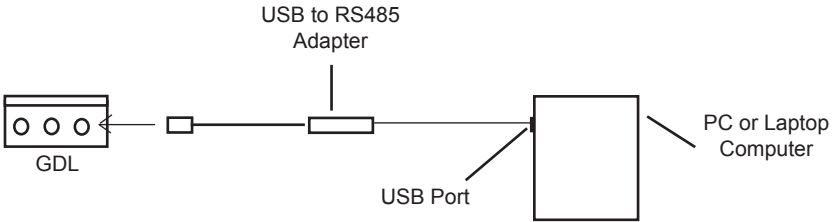

*Connect the sensor to your PC using INW's USB to RS485 adapter. (See Appendix C for alternate connections.)*

---

### Aqua4Plus Software

The GDL comes with the Aqua4Plus host software to install on your PC or laptop. Use this software program the datalogger, to retrieve data from the logger, to view collected data, and to export data to external files for use with spreadsheets or databases.

Each channel on the GDL corresponds to one channel in Aqua4Plus. Thus each time you take a reading, the GDL records data for all active channels. If certain channels are not being used, they can be turned off.

---

## Warm Up Time

Many analog sensors require a warm-up time before readings are stable. The GDL has a programmable field for warm-up time. (Note: the GDL reads all channels each time it takes a reading. Therefore, set this time to the longest warm-up time needed by the particular sensors you have connected, even though some may require a much shorter warm up time.)

Set this warm-up time by clicking on Warm Up Time... on the Configure menu.

---

## Advanced Settings

---

### Basic Configurations

The GDL Datalogger can be configured in a number of ways, depending on the application for which it will be used.

#### Basic Channels:

All GDLs are available with seven basic channels:

Two temperature channels (thermistors)

One milli-volt channel

Two voltage channels

Two 4-20 mA channels

#### Digital Channels:

Various digital channels are also available depending on your application. Digital channels are configured at the factory for the specific equipment that will be connected to them.

---

### Turning Channels On or Off

When your GDL is configured at the factory, every attempt is made to turn on the channels you will need and turn off the ones you will not need. If, however, you find you need to turn on or off any specific channels, you can do so from the Advanced Calibration Window.

- Click the Configure Menu, and then click on Advanced.
- Select Advanced Calibration. (You may be asked for a password. Enter admin.)
- The Advanced Calibration window will display.

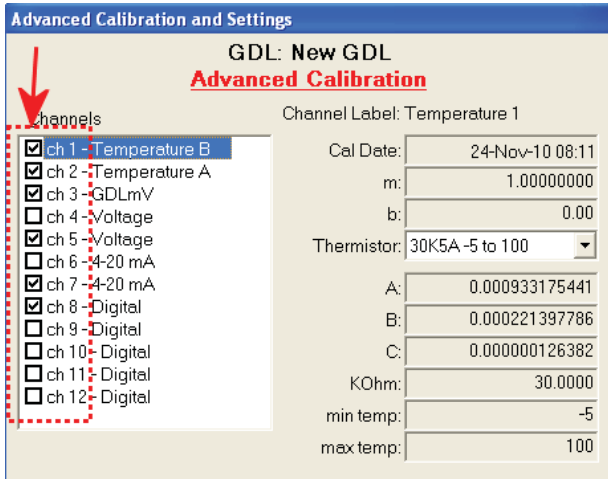

*Turn channels on or off by checking or unchecking the checkboxes.*

- Turn channels on or off by checking or unchecking the checkboxes next to the specific channels. (Depending on how your GDL is configured, your channel list may be slightly different.)
- Click OK to save selections to the sensor.

**Warning:** Be sure you understand how your GDL is wired before turning on or off specific channels. Not all channels may be wired to the outside connectors. (See further wiring details in Appendix B or contact INW.)

## Setting Ranges on Milli-volt and Voltage Channels

The milli-volt and voltage channels are differential measurement channels and each can be set to one of six different ranges. To select the range for a channel:

- Click on the Configure Menu.
- Select Field Calibration.
- In the left panel, click on the channel for which you want to set the range.
- On the right side, click on the down arrow next to the Range box.
- Select the range best suited for your application.

For further information on ranges, see Specifications in Appendix A.

**Field Calibration and Settings**

**GDL: New GDL**

Channels

- 1: Temperature B
- 2: Temperature A
- 3: GDLmV
- 5: Voltage
- 7: 4-20 mA
- 8: Digital

Channel\_Label: mV

Cal Date: unknown

m: 1.000000

b: 0.0000 mV

Range:  $\pm 150$  mV

User Units: mV

Scale: 0.00100000 mV/ $\mu$ V

Offset: 0.0000 mV

Dec Places: 3

Min: 150.000 mV

Max: 150.000 mV

Comment:

Range:  $\pm 150$  mV

- $\pm 150$  mV
- $\pm 75$  mV
- $\pm 37.5$  mV
- $\pm 18.75$  mV
- $\pm 9.375$  mV
- $\pm 4.6875$  mV

*Milli-volt channel  
range options*

Range:  $\pm 5.0$  V

- $\pm 5.0$  V
- $\pm 2.5$  V
- $\pm 1.25$  V
- $\pm 0.600$  V
- $\pm 0.300$  V
- $\pm 0.150$  V

*Voltage channel  
range options*

*From the Range dropdown box, select the milli-volt or voltage range for each milli-volt and voltage channel.*

## Setting the Baud Rate

Your GDL comes configured to communicate at 38,400 baud, with 8 data bits, one stop bit, and no parity. The logger can also be set to 19,200 or 9600 baud, if needed for your application.

If needed, set your GDL to the desired baud rate as follows:

- Click on the Configure menu, and then select Advanced.
- From the flyout menu, select Sensor Baud Rate. (You may be asked for a password. Enter admin.)
- On the popup box, click the down-arrow and select the baud rate you need, and then click OK.



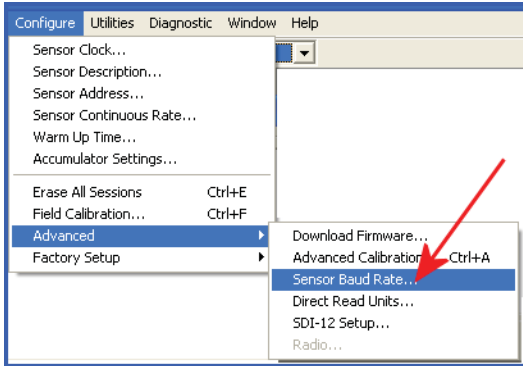

To set the baud rate **on the GDL**, select **Sensor Baud Rate**.

Once you have changed the baud rate on the GDL, you will not be able to talk to it with Aqua4Plus until you change the baud rate for Aqua4Plus, as follows:

- Click the Options menu, and then select Baud Rate.
- On the popup box, click the down-arrow, select the baud rate you need, and then click OK.

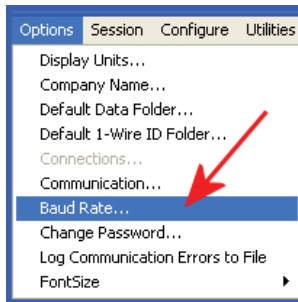

To set the baud rate **on Aqua4Plus**, select **Baud Rate** from the **Options Menu**.

The current Aqua4Plus baud rate is displayed in the lower right corner of the main Aqua4Plus window.

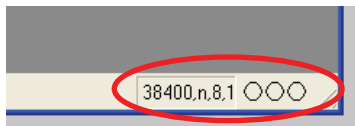

## User Defined Units

In addition to normal unit selections, the milli-volt, voltage, 4-20 mA, and generic digital channels have a User Defined option.

For instance, normally a 4-20 mA channel would have mA and  $\mu$ Amps as units options. If the user has a pressure sensor connected to a 4-20 mA channel, output may be desired in psi. For that there is a User Defined Units option.

### Configure User Defined Units for Milli-volt, Voltage, and 4-20 mA Channels

- Click on the Options Menu, and then select Display Units.
- Select User Defined for each channel type for which you want to define your own units. For example, there are three entries for 4-20 mA channels – mA,  $\mu$ A, and User Defined. Select User Defined.

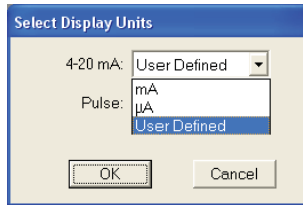

*Select User Defined Units*

- From the Configure window, select Field Calibration. (Refer to next page for an illustration of Field Calibration window.)
- In the left panel, highlight the channel you want to configure. Each channel can have its own user defined units. For example, if you have the first channel connected to a pressure sensor, you might want those units to be psi. If you have the second channel connected to a level gauge, you might want those units in feet of water.
- Determine the ranges of your desired units and your actual units.
  - ◇ Determine the total range of your desired units. For instance, if you want to measure 0 - 15 psi, your desired range would be 15 minus 0, or 15.
  - ◇ Determine the total range of actual measurements. For instance, if you were using the 4-20 mA channel, your actual range would be 20 minus 4, or 16.
- Define your own user units in the Field Calibration window as follows.
  - ◇ User Units: Enter a name for your units in the User Units box. For example, you might enter *psi*.

- ◇ **Scale:** Compute the scale value as follows:
    - $(\text{Total range in your units}) / (\text{Total range in actual units}) / 1000$
    - Using the assumptions above:  
 $15 / 16 / 1000 = .0009375$
    - Enter this value in the box labeled Scale.
  - ◇ **Offset:** Compute the offset value as follows:
    - $\text{Minimum user units} - (\text{scale} * \text{minimum actual units} * 1000)$
    - Using our 0 – 15 psi example above, this would be  
 $0 - (0.0009375 * 4 * 1000) = -3.75$
    - Enter this value in the Offset box.
  - ◇ **Dec Places:** Enter the number of decimal places you want displayed during readings.
  - ◇ **Min and Max:** Enter the minimum and maximum values for your new units. (These values will define the limits on data graph.)
  - ◇ **Comment:** If desired, enter a comment in this box.
- Click OK to save to the sensor.

**Field Calibration and Settings**

**GDL: New GDL**

Channels  
 6: 4-20 mA  
 7: 4-20 mA

Channel Label: 4-20 A

Cal Date: 30-Oct-08 09:55

m: 1.000000

b: 0.0000 psi

User Units: psi

Scale: 0.00093750000 psi/ $\mu$ A

Offset: -3.7500 psi

Dec Places: 3

Min: 0.000 psi

Max: 15.000 psi

Comment: Pressure sensor

Calculator

	First Point	Second Point	Cal Values
Ref psi:			m:
Measured:			b:
	<u>M</u> easure	<u>M</u> easure	<u>A</u> pply

OK Cancel

*Configure User Defined Units on the Field Calibration Window*

---

## Configure User Defined Units for Generic Digital Channels

If your GDL has been configured with Generic Digital channels, you can also set User Defined Units for these channels. User Defined units on these channels work in a similar way to the previously described channels, but each type of sensor will have variations. If you were not provided with specific information for User Defined units on your specific digital channels, contact INW for further information.

(Note: Some digital channels, such as dissolved oxygen and heart rate monitor channels have specific assigned units, so User Defined Units will not be available for those.)

---

## Using Switched Output Voltage

The GDL provides a switched output power that can be used to power your attached sensors. This power is turned on before readings are to be taken and is turned off a few seconds after the readings have finished. This power is normally routed to the sensor connectors on the GDL box. Pin one is positive; pin 5 is ground. (Refer to any application specific documentation that came with your GDL, if you have a custom wired box.)

Use the Configure Menu, Warm Up Time option to set how long before a reading this power is turned on. Note The GDL reads all channels each time it takes a reading. Therefore, this warm-up time should be set to the longest warm-up time needed by the particular sensors you have connected, even though some may require a much shorter warm up time.

The standard configuration for the GDL provides a 12 volt switched output voltage. Optional wiring is available for up to 48 volts at 50 mA. See further information in Appendix B or contact INW for assistance.

---

## Maintenance

---

### Changing Batteries

Because changing the batteries involves opening the weather-tight seal, **this must be done in a clean, dry environment to avoid contamination or moisture damage to the circuitry.**

In standard configuration the GDL runs on eight AA alkaline batteries.

To replace the batteries, remove the four corner screws and lift off the lid. Gently lift out the battery pack. Replace the batteries, and then place the lid on the box, tightening the screws securely. **NOTE: The box is directionally keyed. Failure to replace the lid correctly will prevent a tight seal and will result in water leakage.**

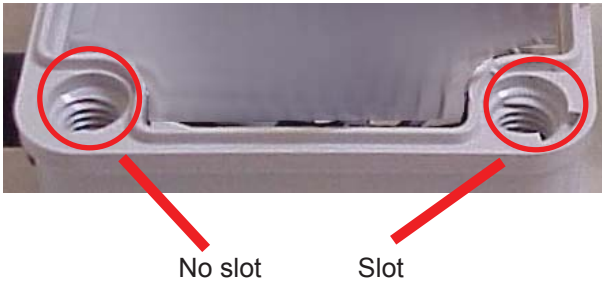

*Note keyed slot in box before replacing lid.*

---

### Calibration

Aqua4Plus provides an easy to use calibration utility that can be used to help calibrate attached sensors. This utility provides a one-point (offset) and a two-point (slope and offset) calibration for each GDL channel. The basic procedure is outlined below. Refer also to the help screen in Aqua4Plus that appears next to the Field Calibration Window.

#### What you will need

Before calibrating, you will need the following:

- Your sensor connected to the GDL box.
- The GDL box connected to your PC, running Aqua4Plus.
- For one-point calibration, a sample of your medium of a known specific value or a sample of your medium and an alternate measuring device. For best results when doing a one-point calibration, select a sample that is representative of what you expect to measure.

- For two-point calibration, two samples of your medium of known specific values or two samples of your medium and an alternate measuring device. For best results when doing a two-point calibration, select samples that bracket your expected measurements.
- For two-point calibration, if you will be moving your sensor from one sample to another, you may need to also have on hand some distilled water to rinse the sensor before placing it in the second sample, so as not to contaminate the sample.

Before calibrating, upload any data you want to keep and erase all sessions from the sensor.

To calibrate a specific channel, select Field Calibration from the Configure Menu, and then click on the channel to be calibrated.

**Field Calibration and Settings**

**GDL: New GDL**

Channels

1: Temperature B  
2: Temperature A  
3: GDLmV  
5: Voltage  
7: 4-20 mA  
8: Digital

Channel Label: Temperature 1

Cal Date: 24-Nov-10 08:11  
m: 0.9545297  
b: 1.04 degC  
Comment:

**Reading Temperature 1**

Measured: 20.909 degC

Click OK when readings have stabilized

OK Cancel

Calculator

	First Point	Second Point	Cal Values
Ref degC:	21	32	m: 0.9545297
Measured:	20.909	32.433	b: 1.042
	Measure	Measure	Apply

*Use Aqua4Plus' built-in calibration utility to help calibrate your attached sensors.*

### **One-Point Calibration:**

#### **— Computing Calibration Value —**

- Place sensor in sample to be measured. Allow time for sensor to stabilize.
- If sample is of a known specific value, enter this value in the **Ref deg** box for the first point.
- Alternately, take a measurement using an accurate alternate measuring device. In the **Ref deg** box for the first point, enter the measured value.
- Click first **Measure** button.
- When readings have stabilized to your satisfaction, click the **OK** button in the pop-up box.

#### **— Applying Calibration Value —**

- Click the **Apply** button to apply calibration value.
- The computed b value will be transferred to the calibration field.
- Click **OK** to save the value to the sensor.

### **Two-Point Calibration:**

#### **— First Calibration Point —**

- Place sensor in sample to be measured. Allow time for sensor to stabilize.
- If first sample is of a known specific value, enter this value in the **Ref deg** box for the first point.
- Alternately, take a measurement using an accurate alternate measuring device. In the **Ref deg** box for the first point, enter the measured value.
- Click first **Measure** button.
- When readings have stabilized to your satisfaction, click the **OK** button in the pop-up box.

#### **— Second Calibration Point —**

- Place sensor in a sample with different value. Allow time for sensor to stabilize.
- If sample is of a known specific value, enter this value in the **Ref deg** box for the first point.
- Alternately, take a measurement using an accurate alternate measuring device. In the **Ref deg** box for the first point, enter the measured value.
- Using an accurate alternate measuring device, take a measurement.
- In the **Ref deg** box for the second point, enter this value.
- Click second **Measure** button.
- When readings have stabilized to your satisfaction, click the **OK** button in the pop-up box.

#### **— Applying Calibration Values —**

- Click the **Apply** button to apply calibration values.
- The computed m and b values will be transferred to the calibration fields.
- Click **OK** to save the values to the sensor.

## Reading the GDL via Direct Read

While the GDL comes with INW's easy to use Aqua4Plus software, you can also use standard Modbus® RTU or SDI-12 equipment to easily take readings, so as to tie into your existing equipment or networks.

You may need to use Aqua4Plus to make a few settings, prior to directly reading the GDL with your equipment. These settings may include units for returned values, baud rate, and SDI-12 command structure. These are described in the following sections.

### Setting Units for Direct Read

By default, the GDL uses the following units:

Temperature	Degrees Celsius
Milli-volt	mV
Voltage	Volts
4-20 mA	mA

However, you can select from a variety of units for direct read measurements. If you want to change to different units, for example, degrees Fahrenheit for temperature or mV for voltage, set these units using Aqua4Plus.

- Click on the Configure menu, and then select Advanced.
- From the flyout menu, select Direct Read Units.
- On the popup box, click the down-arrows next to the channel types you want to change, and then select the units you want.
- Click OK

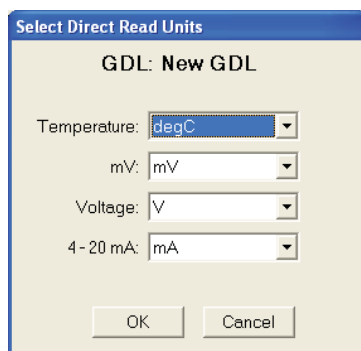

*Use Aqua4Plus to select the units for your direct read measurements, whether Modbus or SDI-12.*

Once set, these units are saved on the sensor and direct readings, either via Modbus or via SDI-12, will return values using these units. (Note: These settings do not affect the units used on the Aqua4Plus display. Refer to the Aqua4Plus software manual for details on using Aqua4Plus.)



## Reading Via Modbus® RTU

### Baud Rate

Your GDL comes configured to communicate at 38,400 baud, with 8 data bits, one stop bit, and no parity. The logger can also be set to 19,200 or 9600 baud, if needed for your application. If needed, set your GDL to the desired baud rate using Aqua4Plus, per instructions earlier in this manual.

### Taking Measurements

#### *Reading Registers*

Read measurements using Modbus function 03 – Read Holding Registers.

Readings are located in two registers each, starting at address 62592. (GDL register address is zero based, i.e., starts at zero. If your equipment uses one based addressing, you will need to add one to the register addresses.)

**Table 1: Register addresses for GDL Data Logger**

<u>Addresses for standard channels</u>		
	Zero Based	One Based
Temperature 1	62592	62593
Temperature 2	62594	62595
mV	62596	62597
Voltage 1	62598	62599
Voltage 2	62600	62601
4-20 mA 1	62602	62603
4-20 mA 2	62604	62605
<u>Addresses for digital channels</u>		
	Zero Based	One Based
<i>If Configured for Dissolved Oxygen</i>		
DO 1	62606	62607
DO Temperature 1	62608	62609
DO 2	62610	62611
DO Temperature 2	62612	62613
DO 3	62614	62615
DO Temperature 3	62616	62617
DO 4	62618	62619
DO Temperature 4	62620	62621
<i>If Configured for Heart Rate Monitor</i>		
Heart Rate	62606	62607
<i>If Configured for Tipping Bucket Rain Gauge</i>		
Rainfall	62606	62607
<i>If Configured for Generic Digital Channels</i>		
Digital 1	62606	62607
Digital 2	62608	62609
Digital 3	62610	62611
Digital 4	62612	62613
Digital 5	62614	62615

For further addressing information and detailed examples, see INW application note, “Modbus Direct Read on Aquistar Smart Sensors” available from our web site at <http://www.inwusa.com/appnotes.htm>.

### *Data Format*

The data is returned as 32-bit IEEE floating-point values, high word first, also referred to as big-endian or float inverse.

### **GDL's Power On Function**

Some devices require a warm-up or stabilization time after application of power before accurate readings can be taken. The GDL provides a means to explicitly turn power on or off to the analog circuit and any devices attached to the switched power output prior to requesting a reading. This same function allows you to specify how long the circuit remains on after a reading has been taken.

There is a “power on” register on the GDL (register 62720 or 0xF500). When a positive value “n” is written to this register, the power is turned on to the sensing probe and remains on for  $n/4$  seconds. When a reading is requested, the timer is reset and the sensing element remains on for another  $n/4$  seconds. To force the power off immediately after a reading, for power savings, write a zero to the register. If the power to the entire GDL sensor is turned off, this value defaults to 30 (or 7.5 seconds).

The recommended procedure to ensure proper warm-up/stabilization and to conserve power is:

- Write Power On value of 30 ( $30/4 = 7.5$  seconds) \*
  - Power turns on
  - Starts sampling about two times per second
- Wait 7 seconds then request a reading \*
  - Returns most recent sample
  - Resets Power On value to 30 ( $30/4 = 7.5$  seconds) \*
- Write Power On value of 0 (zero)
  - Turns power off
  - Retains last reading

*\* If your attached sensors have a longer warm-up/stabilization time, increase these values.*

### **If you Cannot Write to the Power On Register**

If you are reading your device using a meter or other device that cannot write the Power On but simply takes readings on a specified schedule, be sure to set the polling interval to less than 7.5 seconds. This will ensure that the GDL is always providing power to the connected sensors and readings should be fresh and stable. Note that the first reading when you turn on the sensor and meter will be old but will refresh within a second or two.

## Reading Via SDI-12

### Addressing

Default SDI-12 Address: 0

### Channel Setup Using Aqua4Plus

Standard SDI-12 commands are limited to returning a maximum of nine values. The GDL, depending on how it is configured, may have as many as 15 channels. For this reason, Aqua4Plus contains an SDI-12 setup utility to allow you to define which channels are returned for the M or C, M1 or C1, M2 or C2, and M3 or C3 commands.

Open the SDI-12 setup utility from Aqua4Plus by clicking on the Configure Menu and then selecting Advanced. From the flyout menu, select SDI-12 Setup.

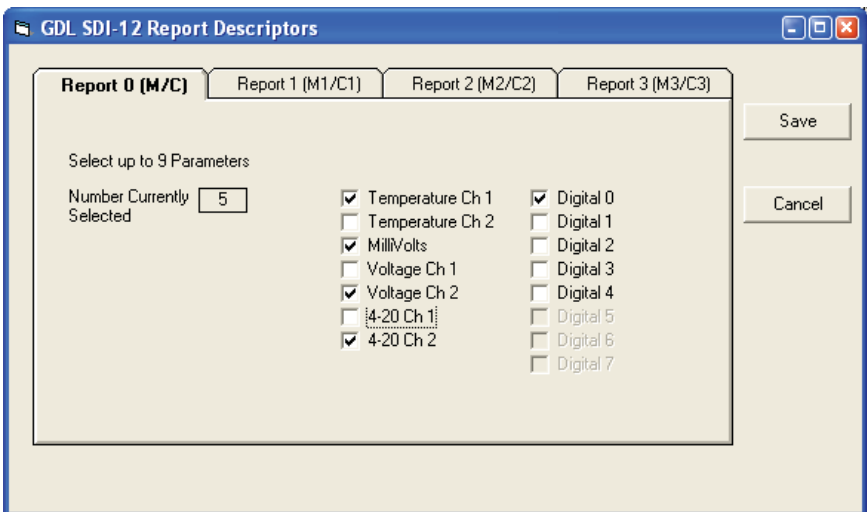

*Use the SDI-12 Setup window to define what values are returned for specific SDI-12 commands.*

This window consists of four tabs, one for the M and C commands, one for the M1 and C1 commands, one for the M2 and C2 commands, and one for the M3 and C3 commands.

On the tab for the command you want to define, checkmark the channels to be returned using this command. A maximum of nine channels can be selected for any command.

Once you have selected the channels for each command you want to use, click on OK to save the information to the logger.

## SDI-12 Command Nomenclature

<a> = Sensor address

{crc} = SDI-12 compatible 3-character CRC

<cr> = ASCII carriage return character

<lf> = ASCII line feed character

**highlighted values** indicate variable data

## SDI-12 Commands

///**\*\*\*** Sensor Identification

<a>I! <a>13 INWUSA GDL**2.9**sssssssss<cr><lf>

// note: 2.9 will change to reflect current firmware revision

// ssssssssss = device serial #

///**\*\*\*** Acknowledge Active, Address Query

<a>! <a><cr><lf>

?! <a><cr><lf>

///**\*\*\*** Change Address

<a>A<b>! <b><cr><lf> // change address to <b>

///**\*\*\*** Request measurement

M!, M1!, M2!, or M3!

Example:

<a>M! <a>0024<cr><lf> // request measurements as set up for M!

<a>D0! <a>**+22.0512+155.0127+155.2155+12.0512**<cr><lf>

///**\*\*\*** Request measurement with CRC

MC!, MC1!, MC2!, or MC3!

Example:

<a>MC! <a>0024<cr><lf> // request measurements as set up for M!

<a>D0! <a>**+22.0512+155.0127+155.2155+12.0512**{crc}<cr><lf>

///**\*\*\*** Concurrent measurement

C!, C1!, C2!, or C3!

Example:

<a>C! <a>00204<cr><lf> // request measurements as set up for C!

<a>D0! <a>**+22.0512+155.0127+155.2155+12.0512**<cr><lf>

///**\*\*\*** Concurrent measurement with CRC

C!, C1!, C2!, or C3!

Example:

<a>CC! <a>00204<cr><lf> // request measurements as set up for C!

<a>D0! <a>**+22.0512+155.0127+155.2155+12.0512**<cr><lf>

## Appendix A: Specifications

### Channel Specifications

#### TEMPERATURE CHANNELS (Thermistor)

<b>Range</b>	-35° C to +105° C (w/ 100 Kohm ref. res.)
<b>Resolution</b>	0.1° C Optional 0.06° C (up to 50°)

(Other ranges and resolutions available)

#### RESISTANCE CHANNELS

<b>Range</b>	300 - 34M ohms
<b>Accuracy</b>	1% or better (300 - 3.7K ohms)
<i>(at 25° C)</i>	0.1% or better (3.7K ohms - 3.2M ohms)
	1% or better (3.2M to 34M ohms)

#### MILLIVOLT CHANNEL

<b>Differential measurement range</b>	± 150mV		
<b>Common mode voltage range</b>	-150mV .. +3.75V		
<b>Ranges</b>	±150 mV	Resolution	4.578 µV
	±75 mV	Resolution	2.289 µV
	±37.5 mV	Resolution	1.144 µV
	±18.5 mV	Resolution	0.572 µV
	±9.375 mV	Resolution	0.286 µV
	±4.6875 mV	Resolution	0.143 µV

**Excitation voltage** 3.00V  
*(for precision excitation of strain gauge sensor)*

#### VOLTAGE CHANNELS

<b>Differential measurement range</b>	± 6.0 V		
<b>Common mode voltage range</b>	-6.0V .. +15.0V		
<b>Ranges</b>	±5 V	Resolution	183.108 µV
	±2.5 V	Resolution	91.554 µV
	±1.25 V	Resolution	45.777 µV
	±0.6 V	Resolution	22.889 µV
	±0.3 V	Resolution	11.444 µV
	±0.15 V	Resolution	5.722 µV

#### 4-20 mA CHANNELS

<b>Range</b>	0 to 24 mA
<b>Resolution</b>	730 nA
<b>Common mode voltage range</b>	0V .. 5.25V

---

## Power Supply

<b>Internal</b> ( <i>AA alkaline cells</i> )	12 VDC or 3 VDC
<b>Auxiliary</b>	6.0V - 24.0V ( <i>not to exceed 24.0V</i> )
<b>Switched voltage output</b>	Standard: 12V ( <i>current limited to 65mA</i> ) Optional: up to 48V at 50 mA

### Power consumption\*

Sleep mode w/ 3 volts	200 uW
Active mode w/ 3 volts	10.5 mW
Sleep mode w/ 12 volts	625 uW
Active mode w/ 12 volts	11 mW

\**Exclusive of digital expansion board and any attached devices*

---

## Enclosure

<b>Material</b>	Polycarbonate (IP67)
<b>Dimensions</b>	5.5" x 3.1" x 2.6" (14 x 7.9 x 6.6 cm) — excluding connectors
<b>Connections</b>	1 communication port 1 or more sensor ports

## Appendix B: Wiring Diagrams

The GDL is a very versatile logger and there are many possible wiring configurations. This appendix describes some of the more common configurations. In some cases, wire seals and/or terminal blocks may be supplied in lieu of sensor connectors. INW will supply wiring diagrams based on your particular sensors and application.

### Communication Connector

The standard GDL configuration comes with one male 5 pin communication connector. Use this for communication with your PC.

Pin	Description
1	12 VDC + ( <i>may or may not be connected depending on application</i> )
2	Modbus D-
3	Modbus D+
4	SDI-12 Signal
5	Ground

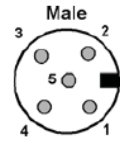

### Standard Sensor Connector

The standard GDL configuration comes with one or more female 5 pin sensor connectors. Use these for connecting your sensors to the GDL. This wiring may vary depending on sensors to be connected. INW will supply wiring diagrams based on your particular sensors.

Pin	Description
1	Switched Voltage Out (12 VDC +)
2	<i>Varies by application</i>
3	<i>Varies by application</i>
4	n/c
5	Ground

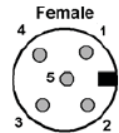

### Dissolved Oxygen Connector

If you purchased a Dissolved Oxygen configuration, then your GDL comes with one or more female 5 pin sensor connectors for connecting your DO sensors to the GDL.

Pin	Description	DO Sensor Wire
1	Switched Voltage Out (12 VDC +)	Red
2	D-	Green
3	D+	White
4	n/c	
5	Ground	Black and Shield

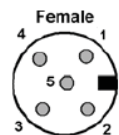

---

## 4-20 mA Connector

4-20 mA channels may come with either an M6 connector or a 5 pin connector.

### M6 Connector

<u>Pin</u>	<u>Description</u>
B	Measurement
D	Signal return
F	Shield

### 5-Pin Connector

Contact INW for wiring information, if not provided with your GDL.

---

## Strain Gauge Wiring

If you will be directly connecting a strain gauge device, contact INW for wiring information.



## Internal Wiring and Connections

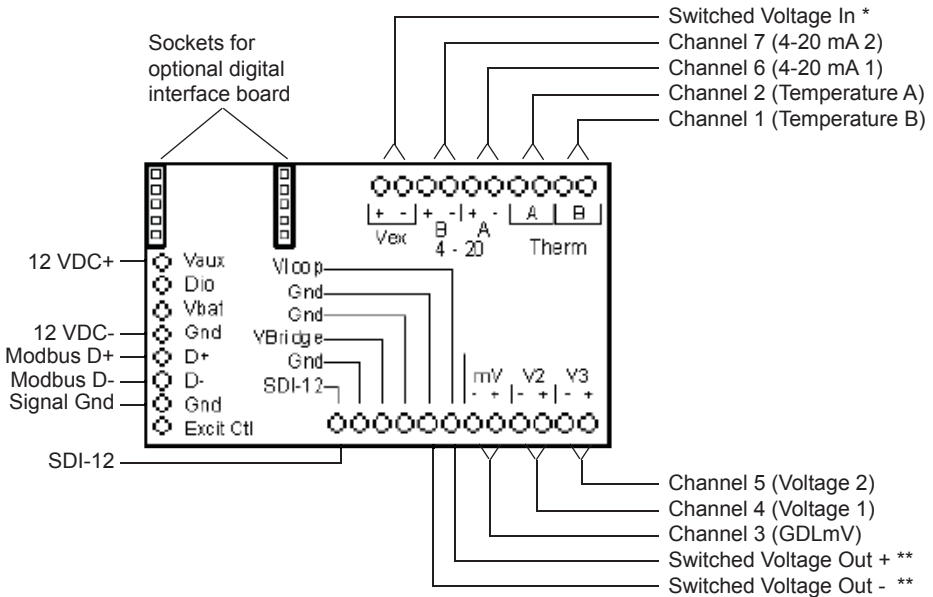

### \* Switched Voltage In

Normally tied to internal 12 VDC supply. Can be connected to outside power supply, instead, up to 48 volts at 50mA. **(To prevent damage to GDL, contact INW before wiring to alternate power supply!)**

### \*\* Switched Voltage Out

Turns on/off when taking readings. See Using Switched Output Voltage earlier in this manual.) Voltage output is equal to that input into the Switched Voltage In.

*Internal wiring and connections.*

---

## Appendix C: Alternate Connection Options

---

### Connecting via RS232 Serial Port

In its cabled configuration, the sensor cable is terminated with a weather-resistant connector. In its cableless configuration, the sensor is terminated with a weather-resistant connector inside a screw-cap. Connect the weather-resistant connector to your computer's serial port as shown below.

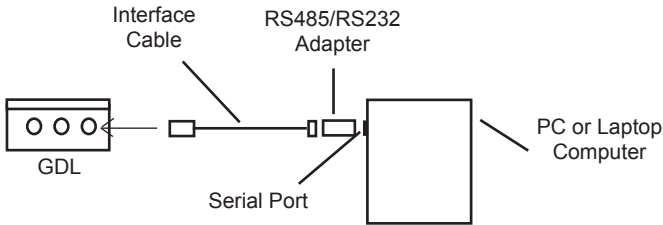

*Connect the sensor to your computer using an RS485/RS232 adapter and an interface cable.*

---

### Connecting with a USB/Serial Adapter

USB-to-Serial cables are readily available from many electronics and computer stores, as well as numerous sites on the Internet. INW has tested and recommends the Keyspan USA-19HS. It is available from INW as well as from many sites on the Internet. Install as follows:

- Plug into USB port.
- Install the drivers provided with the particular unit.
- Determine the port number to which the adapter is assigned.
  - Right-click on My Computer.
  - From the popup menu, select Manage to open the Computer Management window.
  - On left panel, click on Device Manager.
  - On right panel, double-click on Ports.
  - A list of active COM ports will be displayed. Note the COM number assigned to the adapter you just installed.  
For example:  Keyspan USB Serial Port (COM4)
  - Close Manager.
- Connect to the sensor.

- On the Aqua4Plus software, select the COM port noted above. (If you do not see your new COM port in the dropdown box, open the Communications dialog box from the Options menu. Increase the Highest COM port number, up to a maximum of 15.)

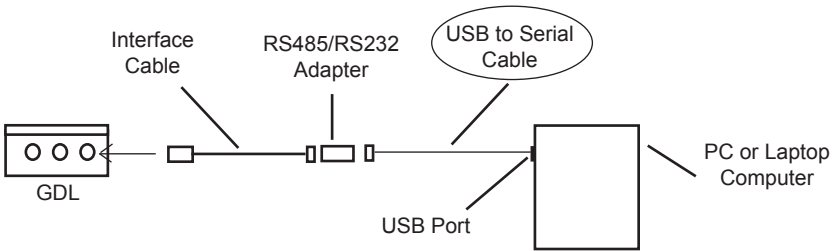

*Connection using a USB to Serial Adapter*

---

## ***Reorder and Contact Information***

For sales & service offices, please contact:

**Instrumentation Northwest, Inc.**

[www.inwusa.com](http://www.inwusa.com)

**800-776-9355**

---

## **LIMITED WARRANTY/DISCLAIMER - *AquiStar*® GDL DATALOGGER**

A. Seller warrants that products manufactured by Seller when properly installed, used, and maintained, shall be free from defects in material and workmanship. Seller's obligation under this warranty shall be limited to replacing or repairing the part or parts or, at Seller's option, the products which prove defective in material or workmanship within ONE (1) year from the date of delivery, provided that Buyer gives Seller prompt notice of any defect or failure and satisfactory proof thereof. Any defective part or parts must be returned to Seller's factory or to an authorized service center for inspection. Buyer will prepay all freight charges to return any products to Seller's factory, or any other repair facility designated by Seller. Seller will deliver replacements for defective products to Buyer (ground freight prepaid) to the destination provided in the original order. Products returned to Seller for which Seller provides replacement under this warranty shall become the property of Seller.

This limited warranty does not apply to lack of performance caused by abrasive materials, corrosion due to aggressive fluids, mishandling or misapplication. Seller's obligations under this warranty shall not apply to any product which (a) is normally consumed in operation, or (b) has a normal life inherently shorter than the warranty period stated herein.

In the event that equipment is altered or repaired by the Buyer without prior written approval by the Seller, all warranties are void. Equipment and accessories not manufactured by the Seller are warranted only to the extent of and by the original manufacturer's warranty.

THE FOREGOING WARRANTIES ARE IN LIEU OF ALL OTHER WARRANTIES, WHETHER ORAL, WRITTEN, EXPRESSED, IMPLIED OR STATUTORY. IMPLIED WARRANTIES OF FITNESS AND MERCHANTABILITY SHALL NOT APPLY. SELLER'S WARRANTY OBLIGATIONS AND BUYER'S REMEDIES THEREUNDER (EXCEPT AS TO TITLE) ARE SOLELY AND EXCLUSIVELY AS STATED HEREIN. IN NO CASE WILL SELLER BE LIABLE FOR CONSEQUENTIAL DAMAGES, LABOR PERFORMED IN CONNECTION WITH REMOVAL AND REPLACEMENT OF THE SENSOR SYSTEM, LOSS OF PRODUCTION OR ANY OTHER LOSS INCURRED BECAUSE OF INTERRUPTION OF SERVICE. A NEW WARRANTY PERIOD SHALL NOT BE ESTABLISHED FOR REPAIRED OR REPLACED MATERIAL, PRODUCTS OR SUPPLIES. SUCH ITEMS SHALL REMAIN UNDER WARRANTY ONLY FOR THE REMAINDER OF THE WARRANTY PERIOD ON THE ORIGINAL MATERIALS, PRODUCTS OR SUPPLIES.

B. With respect to products purchased by consumers in the United States for personal use, the implied warranties including but not limited to the warranties of merchantability and fitness for a particular purpose, are limited to twelve (12) months from the date of delivery.

Some states do not allow limitations on the duration of an implied warranty, so the above limitation may not apply to you. Similarly, some states do not allow the exclusion or limitation of consequential damages, so the above limitation or exclusion may not apply to you. This limited warranty gives you specific legal rights; however, you may also have other rights which may vary from state to state.

Notes:

---



©1997 - 2015 by Instrumentation Northwest, Inc. All rights reserved. Instrumentation Northwest and INW are trademarks registered with the U.S. Patent & Trademark Office. Doc# 9B0842r4 1/13/2015 / PN 6D288-NI



**INW**

8902 122nd Avenue NE  
Kirkland, WA 98033 USA  
425-822-4434

FAX 425-822-8384 / [info@inwusa.com](mailto:info@inwusa.com)

1-800-PRO-WELL  
[WWW.INWUSA.COM](http://WWW.INWUSA.COM)

