

INW DO2

Dissolved Oxygen
Smart Sensor and Datalogger
Instructions



Table of Contents

Introduction	4
What is the INW DO2 Sensor?	4
Initial Inspection and Handling	4
Do's and Don'ts	4
Installation and Operation.....	5
Connecting the DO2 to a Computer	5
Installing the Aqua4Plus Software.....	5
Installing the Sensor	6
Collecting Data	6
Maintenance.....	9
Trouble Shooting.....	10
Erratic Readings.....	10
Grounding Issues	10
Appendix A: Technical Specifications	11
Appendix B: Field Calibration	13
Appendix C: Alternate Connection Options	14
Connecting via RS232 Serial Port	14
Connecting with a USB/Serial Adapter	15
Appendix D: Reading the INW DO2 Sensor	
via Direct Read	16
Reading Via Modbus®.....	16
Setting Baud Rate	16
Reading Via SDI-12.....	18
Appendix E: Error Code Chart	20
Limited Warranty/Disclaimer - INW DO2 Dissolved Oxygen Sensor	23

Introduction

What is the INW DO2 Sensor?

INW's DO2 Smart Sensor is the next generation in trouble-free oxygen sensing design. Utilizing fluorescence of a stable, immobilized ruthenium-based film matrix, the sensor provides precision optical transmission and detection to measure oxygen concentration in the fluid outside of the sensor. The DO2's compatibility with INW's WaveData® Wireless Data Collection technology makes it ideal for remote monitoring.

This industry standard digital RS485 interface device records over 250,000 records of dissolved oxygen, temperature, and power supply voltage data, operates with low power, and features easy-to-use software with powerful features.

The unit is programmed using INW's easy-to-use Aqua4Plus control software. Once programmed the unit will measure and collect data on a variety of time intervals.

The internal microprocessor runs on 12 VDC and automatically turns the sensing unit on and off, as needed, to conserve power.

Initial Inspection and Handling

Upon receipt of your smart sensor, inspect the shipping package for damage. If any damage is apparent, note the signs of damage on the appropriate shipping form. After opening the carton, look for concealed damage, such as a cut cable. If concealed damage is found, immediately file a claim with the carrier.

Do's and Don'ts

Do handle the device with care.

Do store the device in a dry, inside area when not in use.

Do install the device so that the connector end is kept dry.

Don't scratch the sensing window.

Don't support the device with the connector. Use a strain relief device to take the tension off the connectors.

Don't allow the device to free-fall down as well as impact damage can occur.

Don't bang or drop the device on hard objects.

Installation and Operation

Connecting the DO2 to a Computer

The DO2 cable is terminated with a weather-resistant connector. Connect the weather-resistant connector to your computer's USB port as shown below. (For alternate connection options, see Appendix C.)

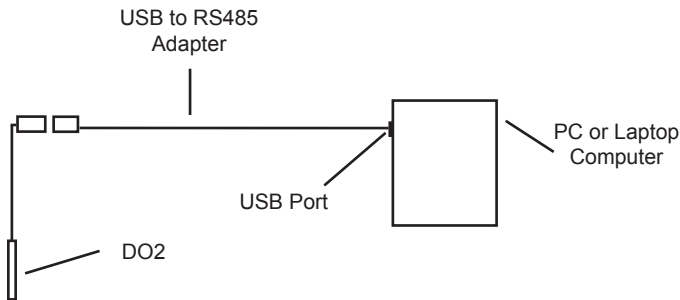

*Connect the DO2 to your PC using a USB to RS485 adapter.
(See Appendix C for alternate connection options.)*

Installing the Aqua4Plus Software

The INW DO2 sensor comes with the Aqua4Plus host software that is installed on your PC or laptop. Use this software to program the datalogger, to retrieve data from the logger, to view collected data, and to export data to external files for use with spreadsheets or databases.

Refer to the Aqua4Plus software manual for details on installing and using Aqua4Plus.

Using the Sensor Without Aqua4Plus

Most users will use the sensor with INW's Aqua4Plus software. However, this sensor is quite versatile, allowing you to do the following:

- Read via the Modbus[®] protocol using your own software.
- Read via SDI-12 protocol.
- Display readings on a panel meter.

If you want to use one of these methods, see Appendix D or contact INW for further details.

Installing the Sensor

Lower the sensor to the desired depth. Fasten the cable to the well head using tie wraps or a weather proof strain-relief system. Take a measurement to insure the sensor is not installed below its maximum range.

Be sure the supplied cap is securely placed on the weather-resistant connector at the top of the cable. Do not install such that the connector might become submerged with changing weather conditions. The connector can withstand incidental splashing but is not designed to be submerged.

Collecting Data

Following is a brief overview on using Aqua4Plus to collect data. Please refer to the *Aqua4Plus Instruction Manual* for further details on configuring and using Aqua4Plus.

Real Time Monitor

Click Single to get a single reading.

Click Start to get a reading once a second.

The unit will power up, run the wiper once, and then start taking readings.

Click Stop to stop the reading.

Note: These are snapshot readings and are not recorded on the sensor.

Real Time Data				Start
Date / Time	Power(V)	DO(ppm)	DO Temp(degC)	Single
22-Feb-13 12:53:22	12.102047	16.689239	23.750000	Clear
22-Feb-13 12:53:23	12.102047	16.689194	23.750000	
22-Feb-13 12:53:24	12.102047	16.689147	23.687500	
22-Feb-13 12:53:25	12.102047	16.689194	23.750000	
22-Feb-13 12:53:26	12.102047	16.689147	23.750000	
22-Feb-13 12:53:27	12.102047	16.689147	23.687500	
22-Feb-13 12:53:28	12.102047	16.689194	23.750000	

The Real Time Monitor gives a snapshot of the current readings on the sensor. (Your view may differ slightly, depending on configuration.)

Setting up a Data Recording Session

Click the  tool button. A Session Profile Window will open. Refer to the *Aqua4Plus Instruction Manual* for details in describing your session profile. Click the Start button to save the session to the sensor and begin recording.

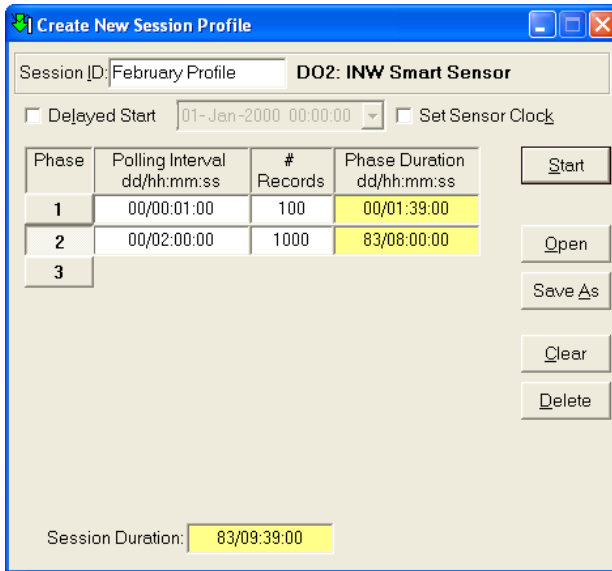

Session ID: February Profile DO2: INW Smart Sensor

Delayed Start 01-Jan-2000 00:00:00 Set Sensor Clock

Phase	Polling Interval dd/hh:mm:ss	# Records	Phase Duration dd/hh:mm:ss
1	00/00:01:00	100	00/01:39:00
2	00/02:00:00	1000	83/08:00:00
3			

Session Duration: 83/09:39:00

Buttons: Start, Open, Save As, Clear, Delete

Using the Session Profile Window, describe the test steps for your particular test.

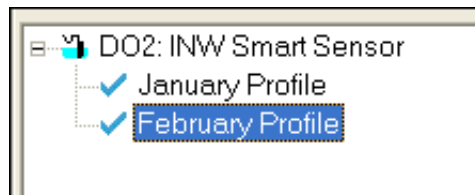

Retrieving Data from the Sensor/Datalogger

- Click on the session you want to upload.
- Click the  tool button.
- Select a file location.
- Click Save.
- Click Start.



Select the data session you are ready to upload.

Viewing Data

- Click the  tool button to view data as a table.
- Click the  tool button to view data as a graph.
- Navigate to the desired file, then click the Open button. (If the File Open box does not appear, click the File Menu, then select Open.)

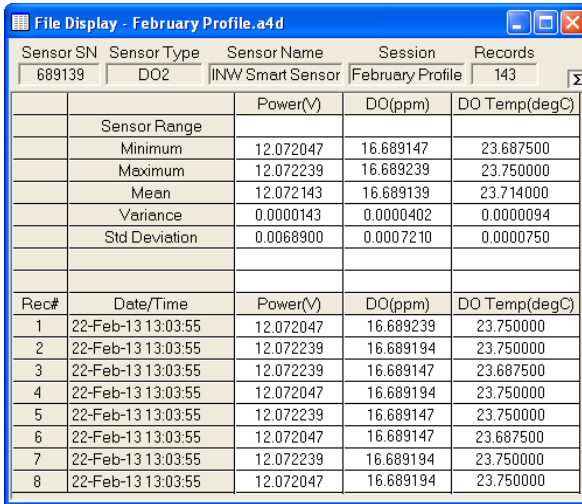

File Display - February Profile.a4d				
Sensor SN	Sensor Type	Sensor Name	Session	Records
689139	DO2	INW Smart Sensor	February Profile	143
		Power(V)	DO(ppm)	DO Temp(degC)
	Sensor Range			
	Minimum	12.072047	16.689147	23.687500
	Maximum	12.072239	16.689239	23.750000
	Mean	12.072143	16.689139	23.714000
	Variance	0.0000143	0.0000402	0.0000094
	Std Deviation	0.0068900	0.0007210	0.0000750
Rec#	Date/Time	Power(V)	DO(ppm)	DO Temp(degC)
1	22-Feb-13 13:03:55	12.072047	16.689239	23.750000
2	22-Feb-13 13:03:55	12.072239	16.689194	23.750000
3	22-Feb-13 13:03:55	12.072239	16.689147	23.687500
4	22-Feb-13 13:03:55	12.072047	16.689194	23.750000
5	22-Feb-13 13:03:55	12.072239	16.689147	23.750000
6	22-Feb-13 13:03:55	12.072047	16.689147	23.687500
7	22-Feb-13 13:03:55	12.072239	16.689194	23.750000
8	22-Feb-13 13:03:55	12.072047	16.689194	23.750000

The File Display Window displays your data in a tabular format.

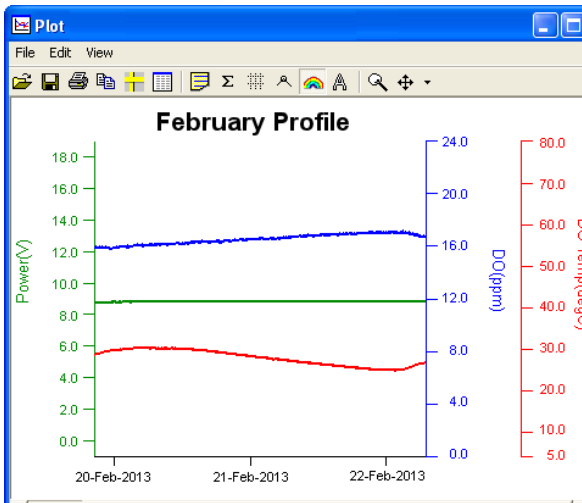

The Graph Window displays your data on an XY coordinate graph.

Exporting Data to .csv or .xls Files

- Using the File Display window, open the file you want to export.
- Click on the  tool button.
- Select a file location and enter a name for the file.
- Select a file type.
- Click Save.

A Word About Units

Readings from the sensor can be displayed in various units, such as degrees Celsius or degrees Fahrenheit for temperature. Select the units you want from the Options | Units menu.

Maintenance

Sensor: There are no user-serviceable parts. If problems develop with sensor stability or accuracy, contact INW. If the unit has been exposed to hazardous materials, do not return without notification and authorization.

Cable: Cable can be damaged by abrasion, sharp objects, twisting, crimping, crushing, or pulling. Take care during installation and use to avoid cable damage. If a section of cable is damaged, it is recommended that you send your sensor back to replace the cable harness assembly.

End Connections: The contact areas (pins & sockets) of the connectors will wear out with extensive use. If your application requires repeated connections other types of connectors can be provided. The connectors used by INW are not submersible, but are designed to be splash-resistant.

DO Window Cleaning: During deployment the sensing window on the DO2 may collect debris or growth. Heavy debris/growth can affect the accuracy of the DO readings over time. Periodically check the window and clean if necessary. Note: the DO window is very sensitive and prone to scratching, DO NOT use abrasive cleaners. We recommend using a wash bottle and DI water to remove the loose debris. If there is a stubborn growth over the window you may clean it with a very soft cloth or Q-tip and a very light touch. Take care not to exert too much pressure or scratch the window surface during cleaning. A mild detergent may be used if necessary, such as Alconox. The main body of the unit may be cleaned with a mild detergent as well.

Trouble Shooting

Erratic Readings

Erratic readings can be caused by a poor connection, damaged cable, moisture in the unit, or a damaged transmitter. In most cases, erratic readings are due to moisture getting into the system. The first thing to check is the connection. Look for moisture between contacts or a loose or broken wire. Next, check the cable for cracking or fraying. If the connections and cable appear OK, but the readings are still erratic, the transmitter may be damaged. Contact INW for evaluation and repair. Erratic and erroneous readings can also occur due to improper grounding. See Grounding Issues, below.

Grounding Issues

It is commonly known that when using electronic equipment, both personnel and equipment need to be protected from high power spikes that may be caused by lightning, power line surges, or faulty equipment. Without a proper grounding system, a power spike will find the path of least resistance to earth ground – whether that path is through sensitive electronic equipment or the person operating the equipment. In order to ensure safety and prevent equipment damage, a grounding system must be used to provide a low resistance path to ground.

When using several pieces of interconnected equipment, each of which may have its own ground, problems with noise, signal interference, and erroneous readings may be noted. This is caused by a condition known as a *Ground Loop*. Because of natural resistance in the earth between the grounding points, current can flow between the points, creating an unexpected voltage difference and resulting erroneous readings.

The single most important step in minimizing a ground loop is to tie all equipment (sensors, dataloggers, external power sources and any other associated equipment) to a **single common grounding point**. INW recommends connecting the shield to ground at the connector end.

Appendix A: Technical Specifications

The INW DO2 Smart Sensor is a microprocessor based digital intelligent sensor designed to measure dissolved oxygen, utilizing fluorescence of a stable, immobilized ruthenium-based film matrix.

GENERAL

Probe Diameter	1.66" (4.22 cm)
Tube Material	Acetal & 316 stainless steel or titanium
Probe Material	Epoxy, polyurethane, and PVC
Wire Seal Material	Fluoropolymer and PTFE
Submersible Cable	Polyurethane, polyethylene, or ETFE available
Terminating Connector	Available
Communication	RS485 Modbus® RTU
Direct Modbus Read Output	32-bit IEEE floating point
Internal Math	32-bit floating point
Operating Temp. Range	0° C to 55° C
Storage Temp. Range	-40° C to 80° C

LOGGING

Memory	260,000+ records
Log Types	Variable, user-defined, logarithmic, profiled
Programmable Baud Rate	9600, 19200, 38400
Logging Rate	8x/sec maximum
Software	Complimentary Aqua4Plus/Aqua4Plus Lite
Networking	32 available addresses per junction w/batching capabilities (up to 255)

SENSOR

File Formats	.xls / .csv / .a4d
Measuring Range	0 - 25 ppm
Accuracy	1% of reading or 0.02 ppm — whichever is greater
Sensitivity / Resolution	0.01 ppm below 4.00, 0.1 ppm above 4.0
Stability	0.01 ppm
Repeatability	0.01 ppm
Sensor Drift	Less than 1% per year
Temperature Range	0° C to 55° C
Response Time	95% in less than 60 seconds
Maximum Pressure	100 PSI

POWER

External Power Pack Required (9-15VDC)

INW Power Pack described below.

Other power options available.

Contact INW for details.

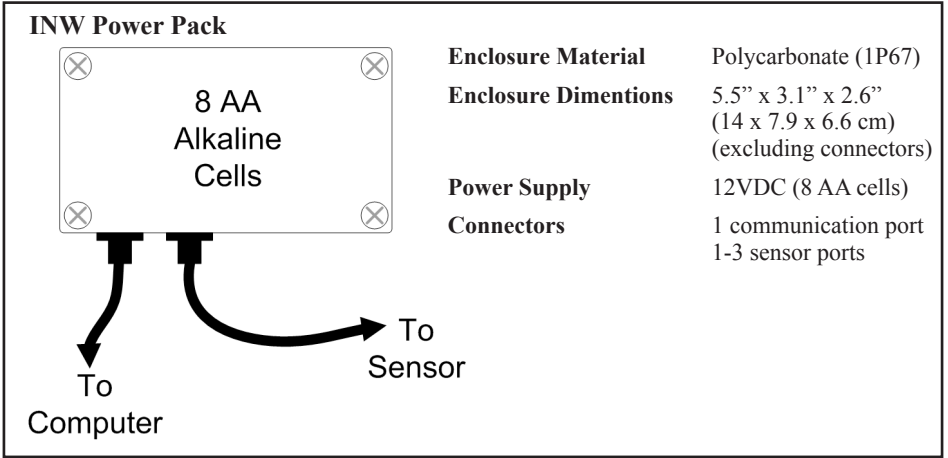

WIRING

For Modbus® —
with 5-pin connector

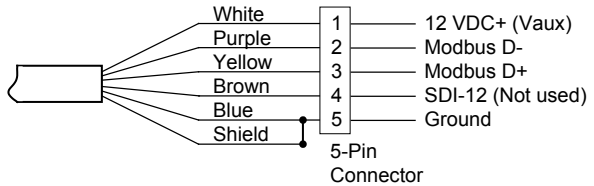

For SDI-12 —
with 5-pin connector

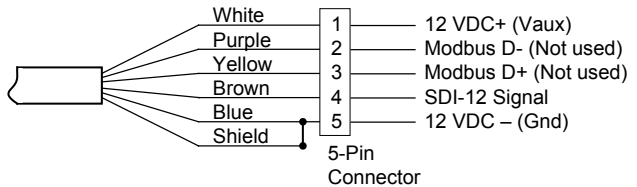

For SDI-12 —
without connector

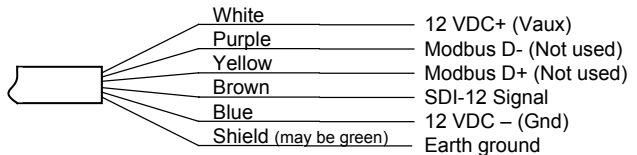

Appendix B: Field Calibration

Calibration can only be done when there are no sessions stored on the sensor. If there are any sessions stored on the sensor, upload any data you want and then erase the session before continuing.

When using firmware 2.3 or later:

-- Must use Aqua4Plus 1.9.302 or higher (1.9.4 or higher recommended). --

- In Aqua4Plus, select Configure=> Advanced => DO2 Probe Calibration.
- Place the DO2 probe in reference solution and allow temperature to fully stabilize.
- Using alternate method, determine DO saturation in ppm.
- Enter this value in the text box on the form.
- Click the Calibrate button - this will trigger the DO probe's internal calibration. This will take a few seconds.
- Once you receive a message that it has calibrated, you can remove it from the reference solution.

When using firmware 2.2 or earlier:

This is older firmware and field calibration has been much improved with firmware 2.3 and higher. Contact your INW representative to inquire about updating your firmware.

One-Point Calibration:

-- Computing Calibration Value --

- Place sensor in sample to be measured. Allow time for sensor to stabilize.
- If sample is of known specific value, enter this value in the Ref box for the first point
- Alternately, using an accurate alternate measuring device, take a measurement. Enter this value in the Ref box for the first point.
- Click first Measure button.
- When readings have stabilized to your satisfaction, click the OK button in the pop-up box.

-- Applying Calibration Value --

- Click the Apply button to apply calibration value.
- The computed b value will be transferred to the calibration field.
- Click OK to save the value to the sensor.

Two-Point Calibration:**-- First Calibration Point --**

- Place sensor in sample to be measured. Allow time for sensor to stabilize.
- If sample is of known specific value, enter this value in the Ref box for the first point
- Alternately, using an accurate alternate measuring device, take a measurement. Enter this value in the Ref box for the first point.
- Click first Measure button.
- When readings have stabilized to your satisfaction, click the OK button in the pop-up box.

-- Second Calibration Point --

- Place sensor in sample with a different value. Allow time for sensor to stabilize.
- If sample is of known specific value, enter this value in the Ref box for the second point
- Alternately, using an accurate alternate measuring device, take a measurement. Enter this value in the Ref box for the second point.
- Click second Measure button.
- When readings have stabilized to your satisfaction, click the OK button in the pop-up box.

-- Applying Calibration Values --

- Click the Apply button to apply calibration values.
- The computed m and b values will be transferred to the calibration fields.
- Click OK to save the values to the sensor.

Appendix C: Alternate Connection Options**Connecting via RS232 Serial Port**

The sensor cable is terminated with a weather-resistant connector. Connect the weather-resistant connector to your computer's serial port as shown below.

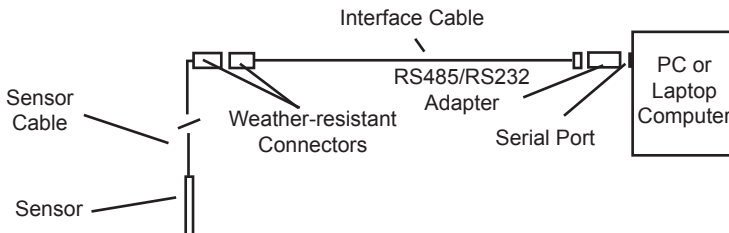

Connect the sensor to your computer using an RS485/RS232 adapter and an interface cable.

Connecting with a USB/Serial Adapter

USB-to-Serial cables are readily available from many electronics and computer stores, as well as numerous sites on the Internet. INW has tested and recommends the Keyspan USA-19HS. It is available from INW as well as from many sites on the Internet. Install as follows:

- Plug into USB port.
- Install the drivers provided with the particular unit.
- Determine the port number to which the adapter is assigned.
 - Right-click on My Computer.
 - From the popup menu, select Manage to open the Computer Management window.
 - On left panel, click on Device Manager.
 - On right panel, double-click on Ports.
 - A list of active COM ports will be displayed. Note the COM number assigned to the adapter you just installed.
For example:  Keyspan USB Serial Port (COM4)
 - Close Manager.
- Connect to the sensor.
- On the Aqua4Plus software, select the COM port noted above. (If you do not see your new COM port in the dropdown box, open the Communications dialog box from the Options menu. Increase the Highest COM port number, up to a maximum of 15.)

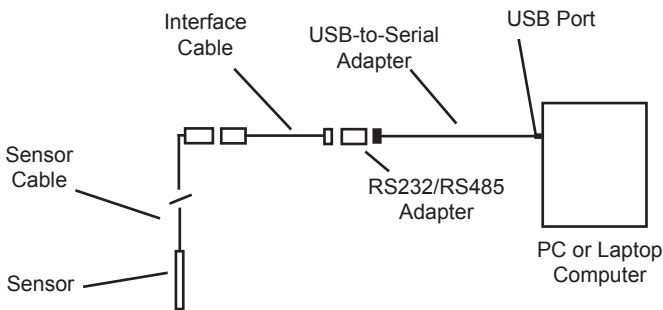

Connection using a USB to Serial Adapter

Appendix D: Reading the INW DO2 Sensor via Direct Read

While the DO2 comes with INW's easy to use Aqua4Plus software, you can also use standard Modbus® RTU or SDI-12 equipment to easily take readings, so as to tie into your existing equipment or networks.

You may need to use Aqua4Plus to set the baud rate. (You do not need to set the baud rate for SDI-12).

Reading Via Modbus®

Setting Baud Rate

Your sensor comes configured to communicate at 38,400 baud, with 8 data bits, one stop bit, and no parity. The sensor can also be set to 19,200 or 9600 baud, if needed for your application.

If needed, set your sensor to the desired baud rate as follows:

- Click on the Configure menu, and then select Advanced.
- From the flyout menu, select Sensor Baud Rate. (You may be asked for a password. Enter admin.)
- On the popup box, click the down-arrow and select the baud rate you need, and then click OK.

Once you have changed the baud rate on the sensor, you will not be able to talk to it with Aqua4Plus until you change the baud rate for Aqua4Plus, as follows:

- Click the Options menu, and then select Baud Rate.
- On the popup box, click the down-arrow, select the baud rate you need, and then click OK.

The current Aqua4Plus baud rate is displayed in the lower right corner of the main Aqua4Plus window.

Taking Measurements

Reading Registers

Read measurements using Modbus function 03 – Read Holding Registers.

Readings are located in two registers each, starting at address 62592. (Sensor register addressing is zero based, i.e., starts at zero. If your equipment uses one based addressing, you will need to add one to the register addresses.)

Note:

The DO2 comes in both a box version and a tube version. The box version may include a barometric sensor, while the tube version does not. If your unit does not have a barometric sensor, any values in the Pressure register should be ignored.

Register addresses for INW DO2 Sensor

	Zero Based	One Based
Temp (on board)	62592	62593
Pressure	62594	62595
Power	62596	62597
DO	62598	62599
Temp (on probe)	62600	62601

Data Format

The data is returned as 32-bit IEEE floating-point values, high word first, also referred to as big-endian or float inverse.

Power On Function

In order to save power, the power to the sensing probe on the DO2 is normally off, even when the DO2 sensor itself is powered. The sensing probe requires a warm-up or stabilization time before returning valid readings. The sensing probe is turned on when a reading is requested or when a Power On command is written to the DO2.

(Note: If you are recording sessions, reading with Aqua4Plus, or using SDI-12, you do not need to be concerned with the stabilization period. It is automatically taken care of in these situations. You only need to be concerned when using your own device to take Modbus readings.)

There is a “power on” register on the DO2 (register 62720 or 0xF500). When a positive value “n” is written to this register, the power is turned on to the sensing probe and remains on for n/4 seconds. When a reading is requested, the timer is reset and the sensing element remains on for another n/4 seconds. To force the power off immediately after a reading, for power savings, write a zero to the register. If the power to the entire DO2 sensor is turned off, this value defaults to 30 (or 7.5 seconds).

Recommendations to ensure proper warm-up/stabilization and to conserve power:

- Write Power On value of 30 (30/4 = 7.5 seconds)
 - Power turns on
 - Starts sampling about two times per second
- Wait 7 seconds then request a reading
 - Returns most recent sample
 - Resets Power On value to 30 (30/4 = 7.5 seconds)
- Write Power On value of 0 (zero)
 - Turns power off
 - Retains last reading

If you Cannot Write to the Power On Register

If you are reading your device using a meter or other device that cannot write the Power On but simply takes readings on a specified schedule, be sure to set the polling interval to less than 7.5 seconds. This will ensure that the sensing probe is always powered up and readings should be fresh and stable. Note that the first reading when you turn on the sensor and meter will be old but will refresh within a second or two.

For further information and detailed Modbus examples, see INW application note, “*Modbus Direct Read on Smart Sensors*” available from our web site at <http://www.inwusa.com/appnotes.htm>.

Reading Via SDI-12

Addressing

Default SDI-12 Address: 0

SDI-12 Command Nomenclature

<a> = Sensor address

{crc} = SDI-12 compatible 3-character CRC

<cr> = ASCII carriage return character

<lf> = ASCII line feed character

highlighted values indicate variable data

SDI-12 Commands

/** Sensor Identification

```
<a>! <a>13 INWUSA SMD02.01sssssssss<cr><lf>
// note: 2.01 will change to reflect current
// firmware revision
// sssssssss = device serial #
```

/** Acknowledge Active, Address Query

```
<a>! <a><cr><lf>
```

```
?! <a><cr><lf>
```

/** Change Address

```
<a>A<b>! <b><cr><lf> // change address from <a> to <b>
```

Note:

The DO2 comes in both a box version and a tube version. The box version may include a barometric sensor, while the tube version does not. If your unit does not have a barometric sensor, the second value returned from the SDI-12 command (M!, MC!, C!, or CC!) should be ignored.

/** Request measurement

```
<a>M! <a>0045<cr><lf> // request all measurements
<a>D0! <a>+23.1374+14.9829+12.1616+3.9829<cr><lf>
// read: temperature (on board),
// pressure
// power
// DO
```

```
<a>D1! <a>+19.1374<cr><lf> // read: temperature (on probe)
```

```

/** Request measurement with CRC
<a>MC! <a>0045<cr><lf> // request all measurements w/CRC
<a>D0! <a>+23.1374+14.9829+12.1616+3.9829{crc}<cr><lf>
// read: temperature (on board),
// pressure
// power
// DO

<a>D0! <a>+19.1374{crc}<cr><lf> // read: temperature (on probe)
/** Concurrent measurement
<a>C! <a>0045<cr><lf> // request all measurements
<a>D0! <a>+23.1374+14.9829+12.1616+3.9829<cr><lf>
// read: temperature (on board),
// pressure
// power
// DO

<a>D0! <a>+19.1374<cr><lf> // read: temperature (on probe)

/** Concurrent measurement with CRC
<a>CC! <a>0045<cr><lf> // request all measurements w/CRC
<a>D0! <a>+23.1374+14.9829+12.1616+3.9829{crc}<cr><lf>
// read: temperature (on board),
// pressure
// power
// DO

<a>D0! <a>+19.1374{crc}<cr><lf> // read: temperature (on probe)

```

For further information and SDI-12 examples, see the INW application note, “*DO2 Interface Specification (SDI-12 and Modbus)*” available from our web site at www.inwusa.com/technical-library.

Appendix E: Error Code Chart

Any reading over 1000 indicates an error, as detailed in the chart below. To use this chart, look up the 1000+ reading from your sensor and note the Sensor Error code in the second column. Then note the Errors 0 – 5. See error descriptions after chart.

		Errors					
Aqua4Plus Reading	Sensor Error Code	5	4	3	2	1	0
1001	01						√
1002	02					√	
1003	03					√	√
1004	04				√		
1005	05				√		√
1006	06				√	√	
1007	07				√	√	√
1008	08			√			
1009	09			√			√
1010	10			√		√	
1011	11			√		√	√
1012	12			√	√		
1013	13			√	√		√
1014	14			√	√	√	
1015	15			√	√	√	√
1016	16		√				
1017	17		√				√
1018	18		√			√	
1019	19		√			√	√
1020	20		√		√		
1021	21		√		√		√
1022	22		√		√	√	
1023	23		√		√	√	√
1024	24		√	√			
1025	25		√	√			√
1026	26		√	√		√	
1027	27		√	√		√	√
1028	28		√	√	√		
1029	29		√	√	√		√
1030	30		√	√	√	√	

Aqua4Plus Reading	Sensor Error Code	Errors					
		5	4	3	2	1	0
1031	31		√	√	√	√	√
1032	32	√					
1033	33	√					√
1034	34	√				√	
1035	35	√				√	√
1036	36	√			√		
1037	37	√			√		√
1038	38	√			√	√	
1039	39	√			√	√	√
1040	40	√		√			
1041	41	√		√			√
1042	42	√		√		√	
1043	43	√		√		√	√
1044	44	√		√	√		
1045	45	√		√	√		√
1046	46	√		√	√	√	
1047	47	√		√	√	√	√
1048	48	√	√				
1049	49	√	√				√
1050	50	√	√			√	
1051	51	√	√			√	√
1052	52	√	√		√		
1053	53	√	√		√		√
1054	54	√	√		√	√	
1055	55	√	√		√	√	√
1056	56	√	√	√			
1057	57	√	√	√			√
1058	58	√	√	√		√	
1059	59	√	√	√		√	√
1060	60	√	√	√	√		
1061	61	√	√	√	√		√
1062	62	√	√	√	√	√	
1063	63	√	√	√	√	√	√
1128	Unable to communicate with sensor						

ERROR DESCRIPTION

- 0 = Main photodiode saturated (circuit or sensor coating damage)
- 1 = Main photodiode negative (excessive electrical noise or damage)
- 2 = Reference photodiode saturated (circuit or sensor coating damage)
- 3 = Reference photodiode negative (excessive electrical noise or damage)
- 4 = Temperature error (thermistor is damaged)
- 5 = Temperature error (temperature is out of range)

**LIMITED WARRANTY/DISCLAIMER - INW DO2
DISSOLVED OXYGEN SENSOR**

A. Seller warrants that products manufactured by Seller when properly installed, used, and maintained, shall be free from defects in material and workmanship. Seller's obligation under this warranty shall be limited to replacing or repairing the part or parts or, at Seller's option, the products which prove defective in material or workmanship within TWO (2) years from the date of delivery, provided that Buyer gives Seller prompt notice of any defect or failure and satisfactory proof thereof. Any defective part or parts must be returned to Seller's factory or to an authorized service center for inspection. Buyer will prepay all freight charges to return any products to Seller's factory, or any other repair facility designated by Seller. Seller will deliver replacements for defective products to Buyer (ground freight prepaid) to the destination provided in the original order. Products returned to Seller for which Seller provides replacement under this warranty shall become the property of Seller.

This limited warranty does not apply to lack of performance caused by abrasive materials, corrosion due to aggressive fluids, mishandling or misapplication. Seller's obligations under this warranty shall not apply to any product which (a) is normally consumed in operation, or (b) has a normal life inherently shorter than the warranty period stated herein.

In the event that equipment is altered or repaired by the Buyer without prior written approval by the Seller, all warranties are void. Equipment and accessories not manufactured by the Seller are warranted only to the extent of and by the original manufacturer's warranty.

THE FOREGOING WARRANTIES ARE IN LIEU OF ALL OTHER WARRANTIES, WHETHER ORAL, WRITTEN, EXPRESSED, IMPLIED OR STATUTORY. IMPLIED WARRANTIES OF FITNESS AND MERCHANTABILITY SHALL NOT APPLY. SELLER'S WARRANTY OBLIGATIONS AND BUYER'S REMEDIES THEREUNDER (EXCEPT AS TO TITLE) ARE SOLELY AND EXCLUSIVELY AS STATED HEREIN. IN NO CASE WILL SELLER BE LIABLE FOR CONSEQUENTIAL DAMAGES, LABOR PERFORMED IN CONNECTION WITH REMOVAL AND REPLACEMENT OF THE SENSOR SYSTEM, LOSS OF PRODUCTION OR ANY OTHER LOSS INCURRED BECAUSE OF INTERRUPTION OF SERVICE. A NEW WARRANTY PERIOD SHALL NOT BE ESTABLISHED FOR REPAIRED OR REPLACED MATERIAL, PRODUCTS OR SUPPLIES. SUCH ITEMS SHALL REMAIN UNDER WARRANTY ONLY FOR THE REMAINDER OF THE WARRANTY PERIOD ON THE ORIGINAL MATERIALS, PRODUCTS OR SUPPLIES.

B. With respect to products purchased by consumers in the United States for personal use, the implied warranties including but not limited to the warranties of merchantability and fitness for a particular purpose, are limited to twenty four (24) months from the date of delivery.

Some states do not allow limitations on the duration of an implied warranty, so the above limitation may not apply to you. Similarly, some states do not allow the exclusion or limitation of consequential damages, so the above limitation or exclusion may not apply to you. This limited warranty gives you specific legal rights; however, you may also have other rights which may vary from state to state.



Seametrics • 19026 72nd Avenue South • Kent, Washington 98032 • USA
(P) 253.872.0284 • (F) 253.872.0285 • 1.800.975.8153 • inwusa.com

LT-14406r5.0 20161118 11/18/16